

MODEL: 02262

ASSEMBLY INSTRUCTIONS

READ AND SAVE THESE INSTRUCTIONS

UNPACK THE FOUNTAIN

YOU SHOULD HAVE RECEIVED THE FOLLOWING PARTS:
FOUNTAIN BODY, PANEL, PUMP WITH LIGHT, (2) BULBS,
TRANSFORMER, (2) CORD COVERS, CHANNEL, (2) PLASTIC
ANCHORS AND (2) WOOD SCREWS.

FOUNTAIN ASSEMBLY

1. FEED LIGHT POWER CORD THROUGH HOLE IN
ENTRY ON BACK OF FOUNTAIN BODY AND INSERT
THE BULB INTO BULB CLIP IN RESERVOIR.

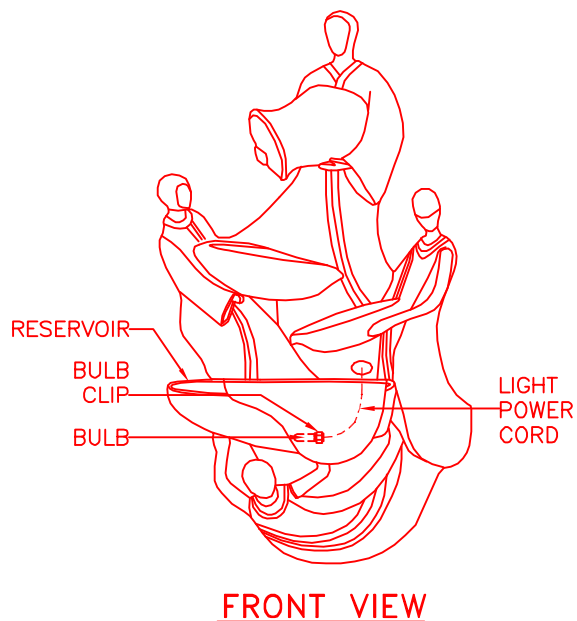
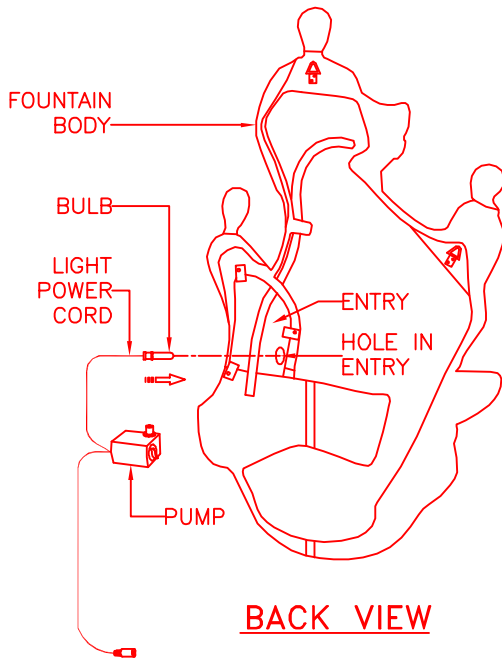

2. ATTACH PUMP TO RUBBER HOSE AND PLACE
THE PUMP FLAT IN RESERVOIR AS SHOWN.

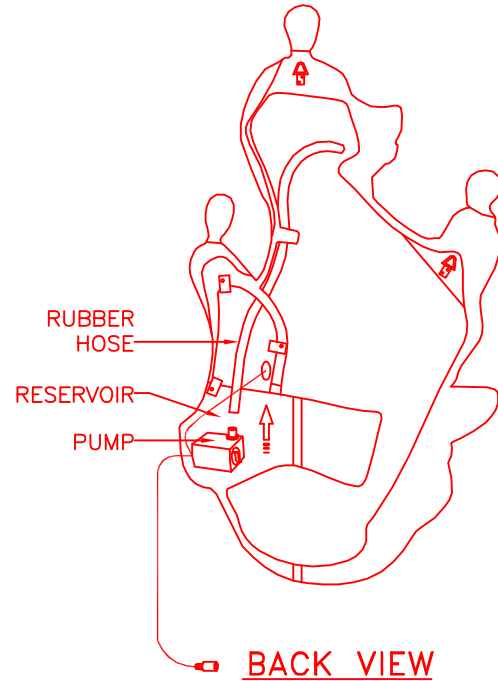

3. PLACE PANEL ON BACK OF FOUNTAIN BODY
TO COVER ENTRY AND SECURE WITH 3-CLIPS.

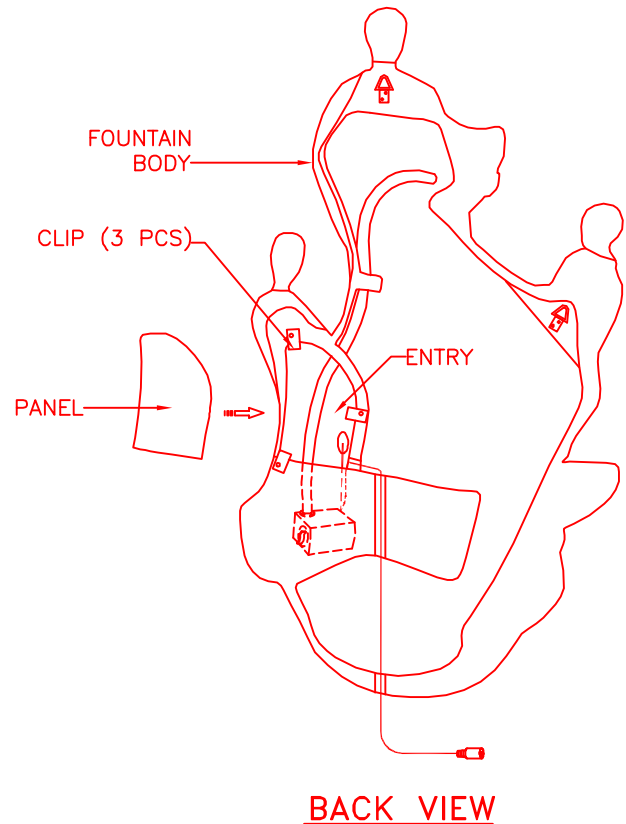

MODEL: 02262

ASSEMBLY INSTRUCTIONS

READ AND SAVE THESE INSTRUCTIONS

FOUNTAIN ASSEMBLY

4. LOCATE DESIRED POSITION ON WALL.

5. INSTALL WALL ANCHORS IN WALL AND HANG FOUNTAIN SECURELY ON BRACKETS. (HARDWARE NOT INCLUDED. CONTACT YOUR LOCAL HARDWARE PROFESSIONAL TO CHOOSE AN ATTACHMENT MECHANISM APPROPRIATE FOR YOUR WALL)

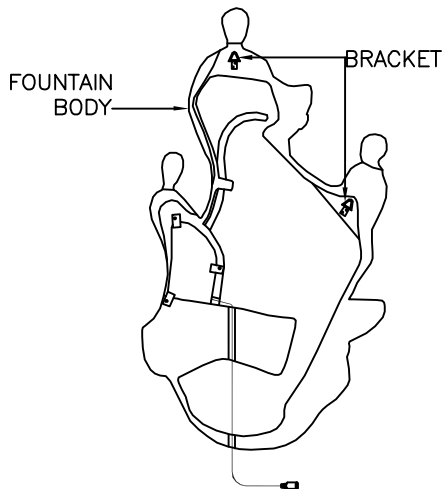

BACK VIEW

6. TO INSTALL CORD COVER, MOUNT CHANNEL ON THE WALL WITH WOOD SCREWS AND ANCHORS. PLACE CORD INSIDE CHANNEL AND PRESS CORD COVER SECURELY ONTO CHANNEL.

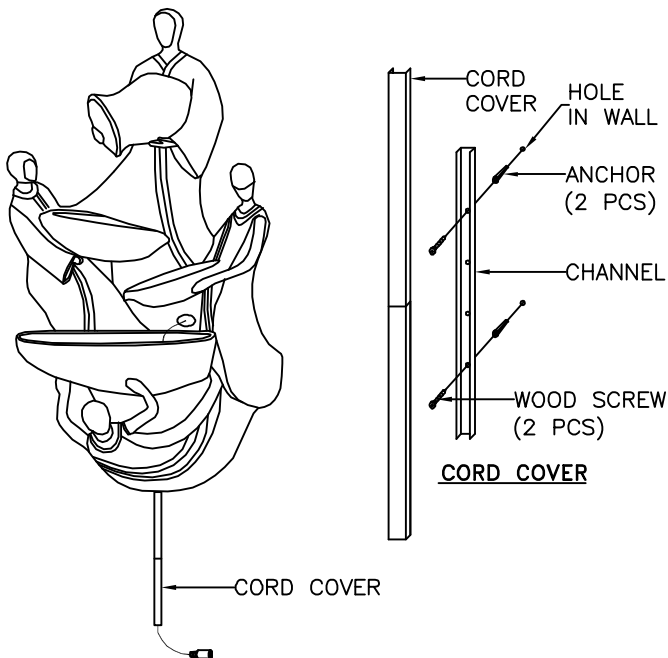

7. JOIN THE CONNECTORS TOGETHER.

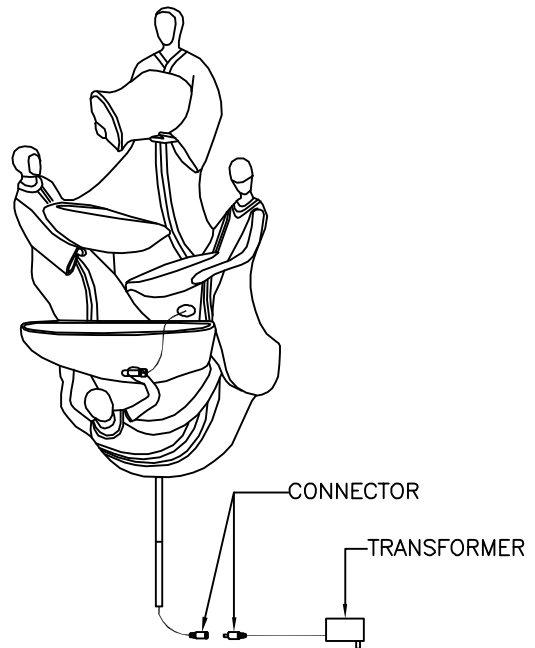

8. FILL RESERVOIR WITH ENOUGH WATER TO COMPLETELY SUBMERSE PUMP. (DISTILLED WATER IS RECOMMENDED TO REDUCE MINERAL DEPOSITS AND BACTERIA BUILD-UP.)

9. PLUG TRANSFORMER INTO SOCKET, YOUR NEW FOUNTAIN IS READY TO USE.

TROUBLE SHOOTING:

1. IF YOUR FOUNTAIN DOES NOT WORK, CHECK PLUG AT THE SOCKET. MAKE SURE THE PLUG IS FULLY AND PROPERLY INSERTED INTO THE WALL OUTLET.
2. NEXT CHECK TO MAKE SURE THE OUTLET IS POWERED.
3. IF THE FOUNTAIN STILL DOES NOT WORK, PLEASE CONTACT YOUR DISTRIBUTOR OR PLACE OF PURCHASE.

SPLASHING DISCLAIMER:

SPLASHING MAY OCCUR WHEN FOUNTAIN IS INITIALLY TURNED ON. PROTECT SURROUNDING SURFACES AS NEEDED.

IMPORTANT PUMP INFORMATION:

PUMP MUST BE FULLY SUBMERSED IN WATER WHILE OPERATING.

WATER:

TO REDUCE MINERAL DEPOSITS AND BACTERIA BUILD UP THE USE OF DISTILLED WATER IS RECOMMENDED.

IMPORTANT SAFETY INSTRUCTIONS:

THIS FOUNTAIN IS RATED FOR INDOOR USE ONLY.

WARNING:

*ONCE A WEEK INSPECT FOUNTAIN, FLOOR AND ADJACENT WALL FOR MOISTURE BUILD-UP AND CLEAN AS NECESSARY. THIS IS ESPECIALLY IMPORTANT FOR HUMID ENVIRONMENTS.

**THIS UNIT MUST BE CONNECTED TO A SUPPLY CIRCUIT THAT IS PROTECTED BY A GROUND FAULT CIRCUIT INTERRUPTER (GFCI). THE GFCI SHOULD BE TESTED ON A ROUTINE BASIS. TO TEST THE GFCI, PUSH THE TEST BUTTON. THE GFCI SHOULD INTERRUPT POWER. PUSH THE RESET BUTTON. POWER SHOULD BE RESTORED. IF THE GFCI FAILS TO OPERATE IN THIS MANNER, THE GFCI IS DEFECTIVE.