

2

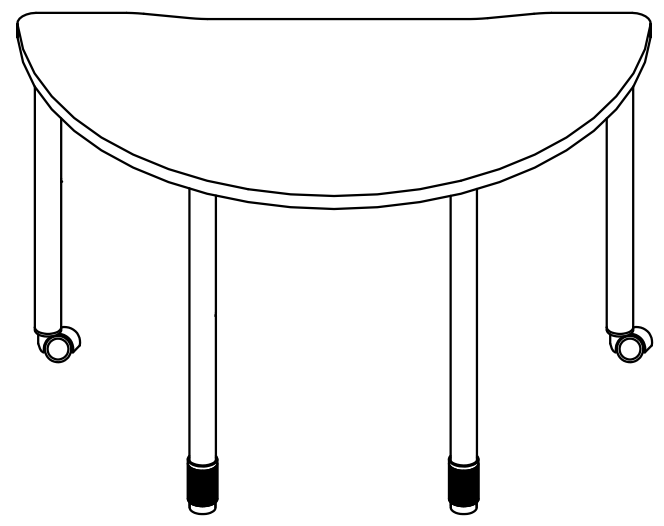

66180

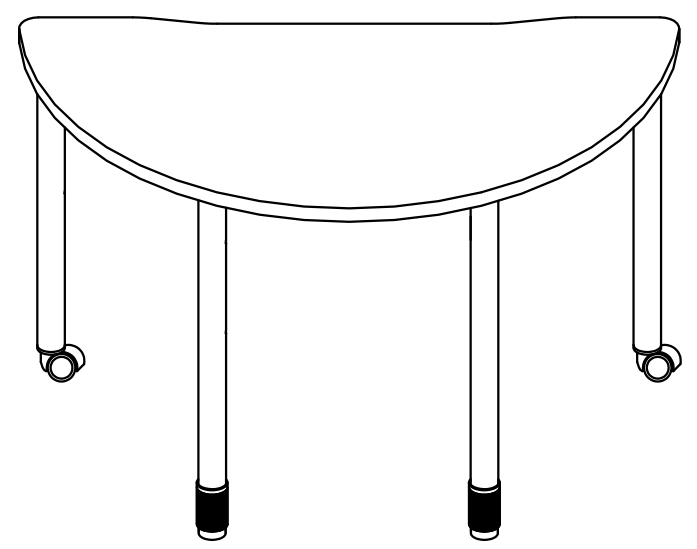

3

4

1

66180

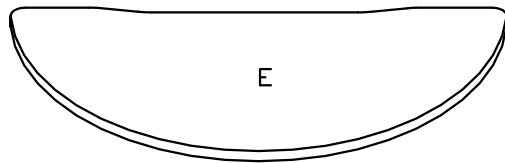

E

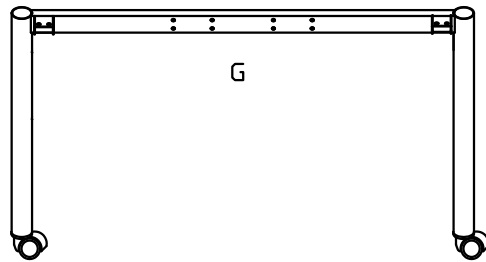

G

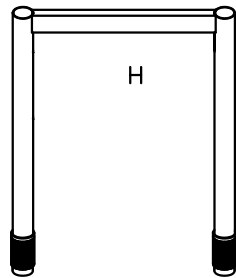

H



K

24-M6x16mm

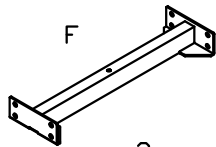

F

x2

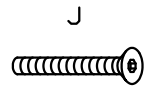

J

2-M6x55mm

2

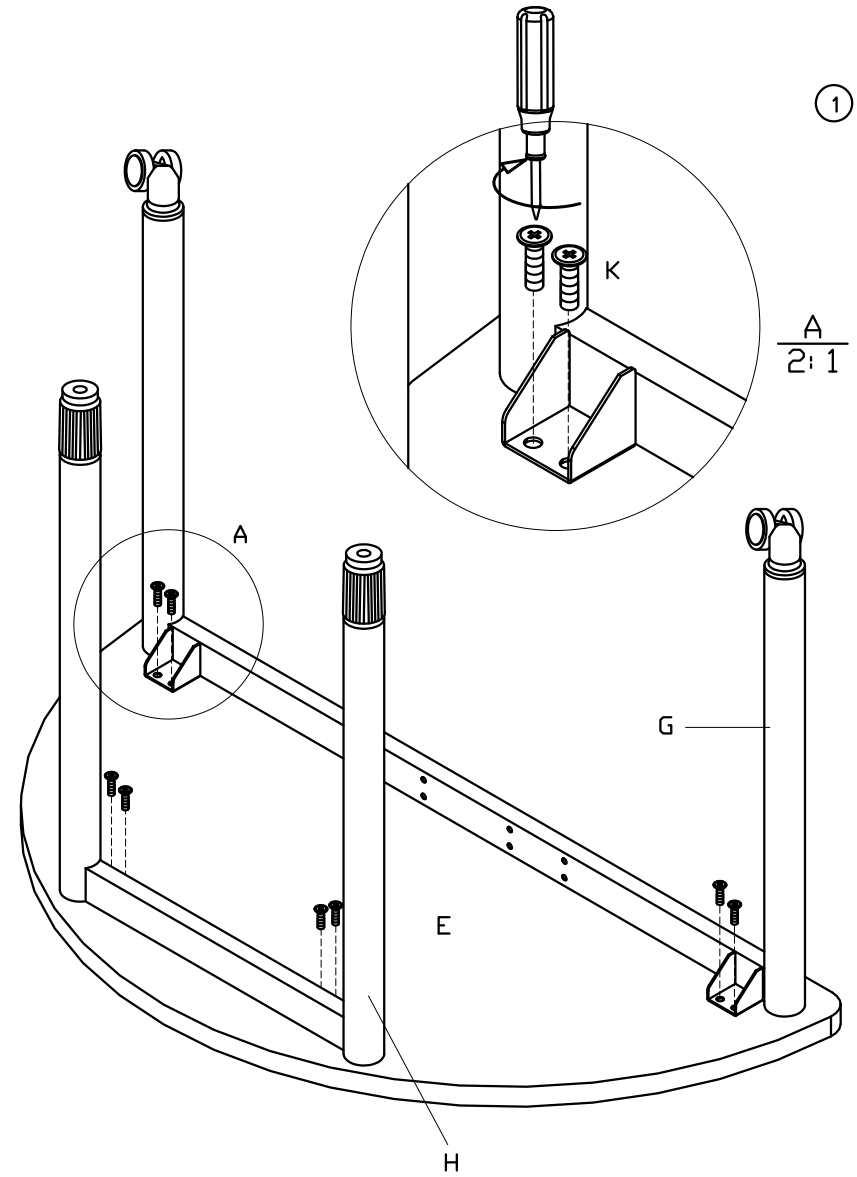

1

$\frac{A}{2:1}$

3