

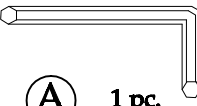

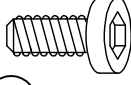



Components and Hardware List

5mm Allen Wrench  (A) 1 pc.	M5/16" x 3/4" Allen Head Bolt  (B) 12 pcs.	5/16" Spring Washer  (C) 12 pcs.	5/16" x 18mm Flat Washer  (D) 12 pcs.
TOP  (E) 1 pc.	LEG  (F) 4 pcs.	BOTTOM SHELF  (G) 1 pc.	

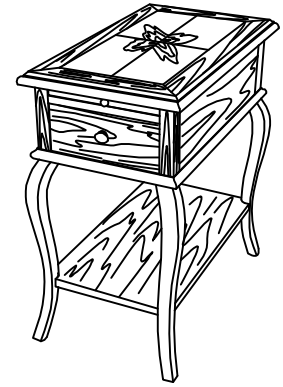

72011
Chairside Table

Be sure to check all packing material carefully for small parts, which may have come loose inside the carton during shipment.

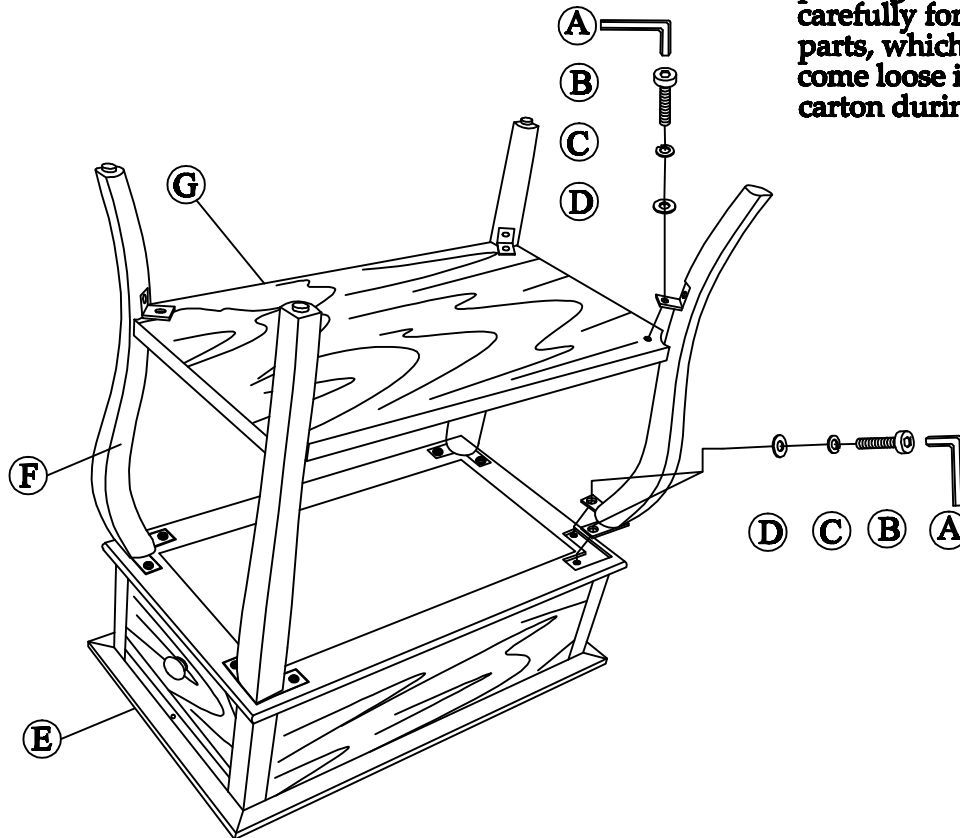

Notes:

- 1: To prevent possible scratches or damage, assemble the table upside down on a soft surface such as a blanket or carpet.
- 2: Attach four Legs (F) to the Top (E), with Flat Washers (D), Spring Washers (C), and Allen Head Bolts (B). Do not fully tighten until after next step.
- 3: Attach the Bottom Shelf (G) to the Legs (F), with Flat Washers (D), Spring Washers (C), and Allen Head Bolts (B).
- 4: Using the Allen Wrench (A), tighten the eight Bolts at the top of the Legs and then tighten the Bolts connecting the Bottom Shelf to the Legs.
- 5: Carefully turn the table upright.
- 6: If necessary, the levelers / floor glides in the bottom of the legs can be adjusted to level the table.